

# Dimensions

## 1. Indoor Unit

### 1.1 CS-RU24AKH

<Top View>

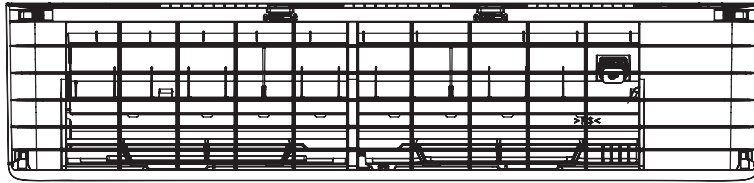

<Side View>

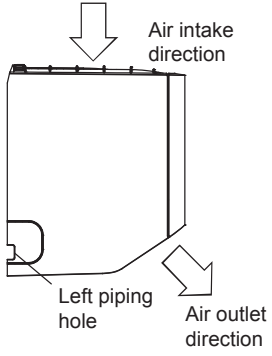

<Front View>

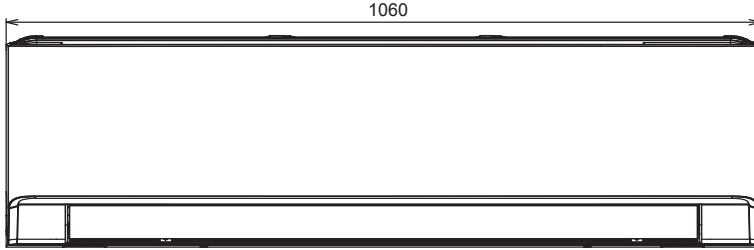

<Side View>

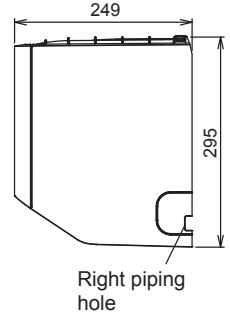

<Bottom View>

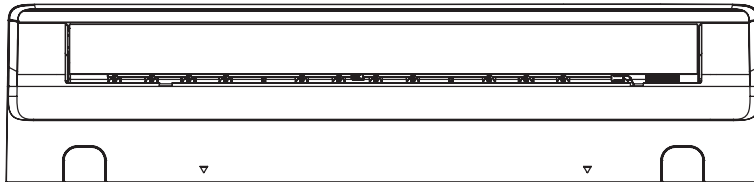

<Remote Control>

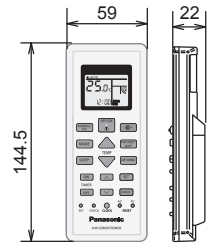

<Rear View>

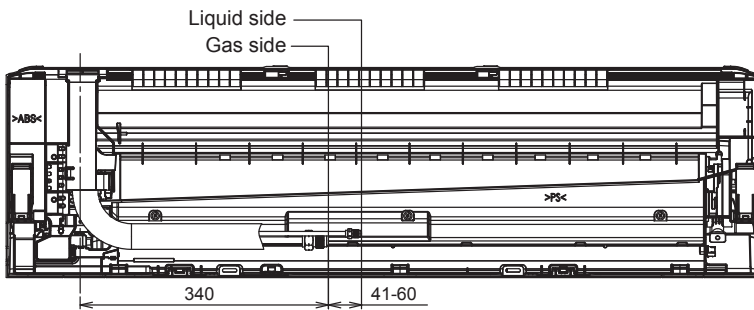

<Remote Control Holder>

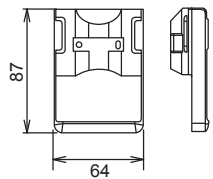

Relative position between the indoor and the installation plate <Front View>

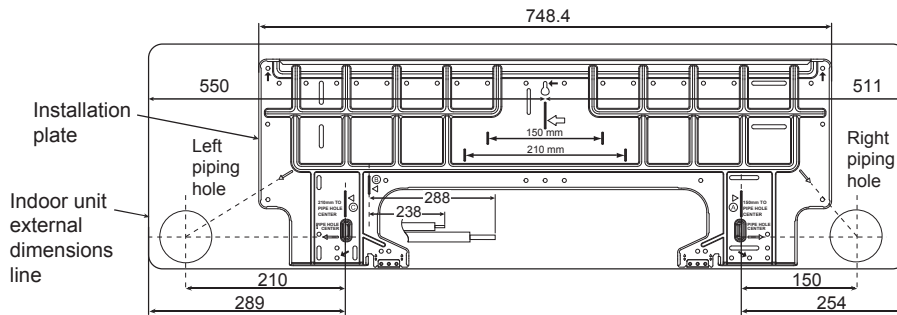

Unit : mm

## 2. Outdoor Unit

### 2.1 CU-RU24AKH

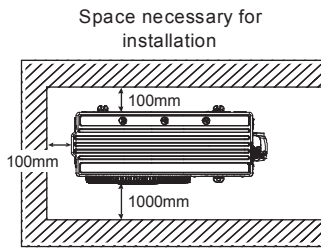

Anchor Bolt Pitch  
330 × 540

<Top View>

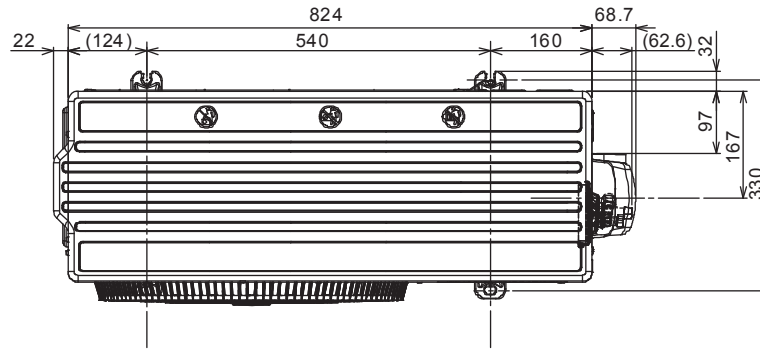

<Side View>

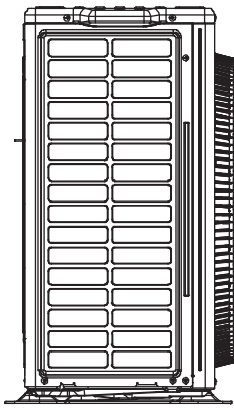

<Front View>

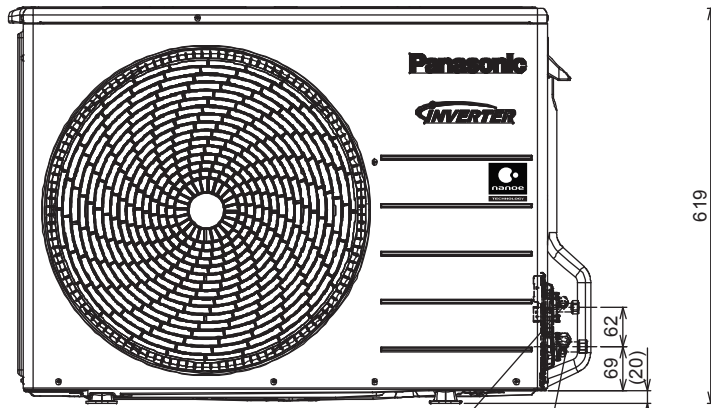

<Side View>

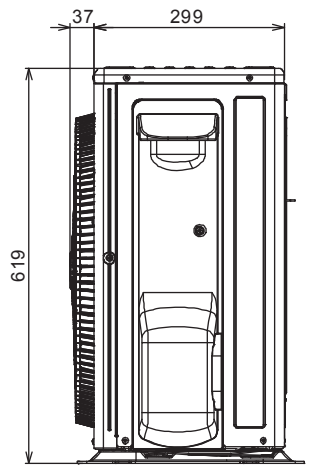

Unit : mm

3-way valve at Gas side  
(Low Pressure)  
2-way valve at Liquid side  
(High Pressure)